

CILINDRI TONDI INOX CP04 Ø32-40 STAINLESS STEEL CP04 ROUND CYLINDERS Ø32-40

DOPPIO EFFETTO
DOUBLE ACTING

CDEIØ/...D

CDEMIØ/...D

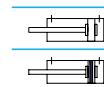
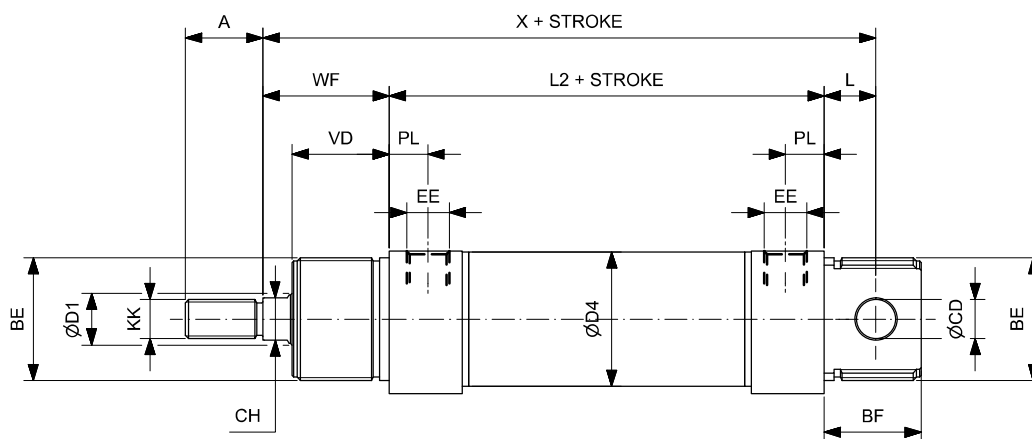
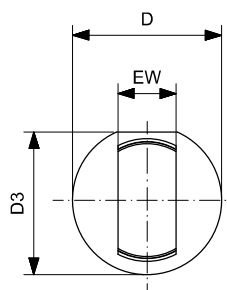

Ømm	ØD1	KK	A	CH	BE	WF	VD	PL	EE	X	L2	L	ØD4	ØCD	BF	D	EW	D3
32	12	M10X1.25	22	10	M30X1.5	34	26	9	1/8"G	117.5	69.5	14	33.6	10	26	38	16	36.5
40	16	M12X1.25	24	13	M38X1.5	39	30	12	1/4"G	139.5	84.5	16	41.6	12	30	46	18	44

DOPPIO EFFETTO PASSANTE
DOUBLE ACTING THROUGH PISTON ROD

CDEPIØ/...D

CDEMPIØ/...D

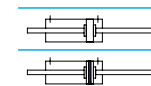
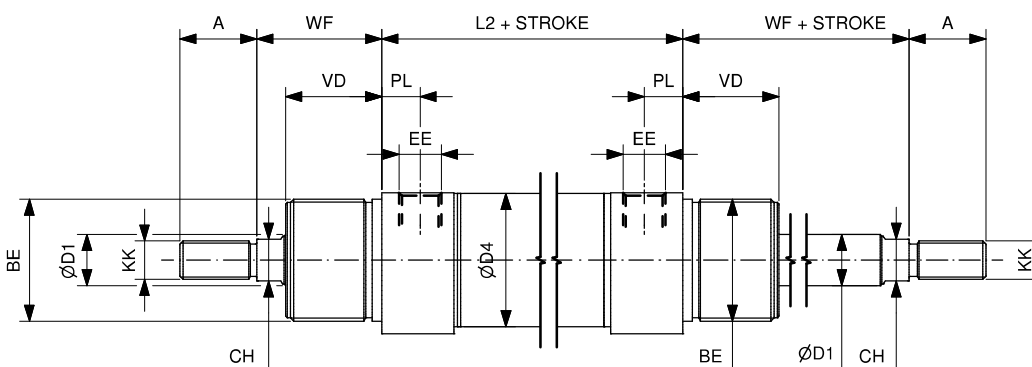
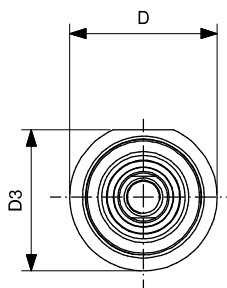

Ømm	ØD1	KK	A	CH	BE	WF	VD	PL	EE	L2	ØD4	D	D3
32	12	M10X1.25	22	10	M30X1.5	34	26	9	1/8"G	69.5	33.6	38	36.5
40	16	M12X1.25	24	13	M38X1.5	39	30	12	1/4"G	84.5	41.6	46	44

ACCESSORI DI FISSAGGIO
MOUNTING ACCESSORIES

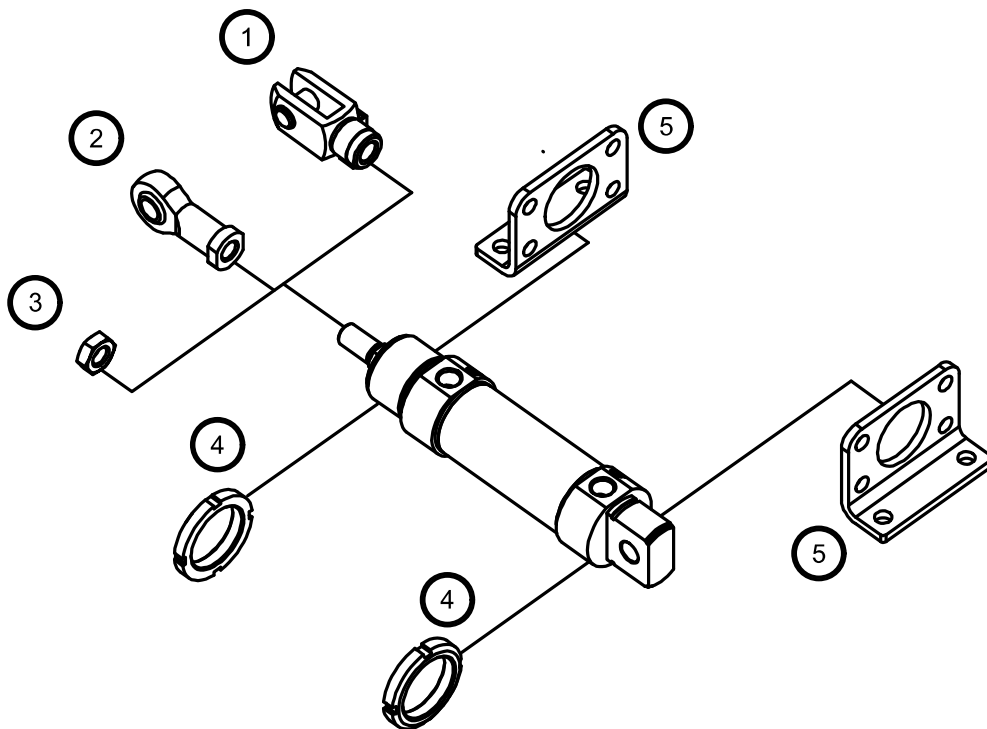

Descrizione Description	Acciaio inox Stainless steel
1 Forcella / Clevis	147
2 Testa a snodo / Rod end	148
3 Dado per stelo / Piston rod nut	146
4 Ghiera / Slotted nut	147
5 Piedino flangia / Foot flange	154